



12" Grab Bar
8001012

Features

- Installs from front of wall
- Adjustable mounting brackets fit your specific installation requirements
- Anodized aluminum
- Elliptical shape makes the bar easier to grip
- Available in finishes to coordinate with nickel and silver shower door finishes

Included Components

Additional Components:
Installation hardware



Codes/Standards

ASTM F446

STERLING® Warranty - Grab Bars

See website for detailed warranty information.

Available Colors/Finishes

Color tiles intended for reference only.

Color	Code	Description
	N	Nickel
	V	Matte Silver

1-800-STERLING (1-800-783-7546)

Kohler Co. reserves the right to make revisions without notice to product specifications.

For the most current Specification Sheet, go to www.sterlingplumbing.com.

4-26-2019 01:54 - US/CA

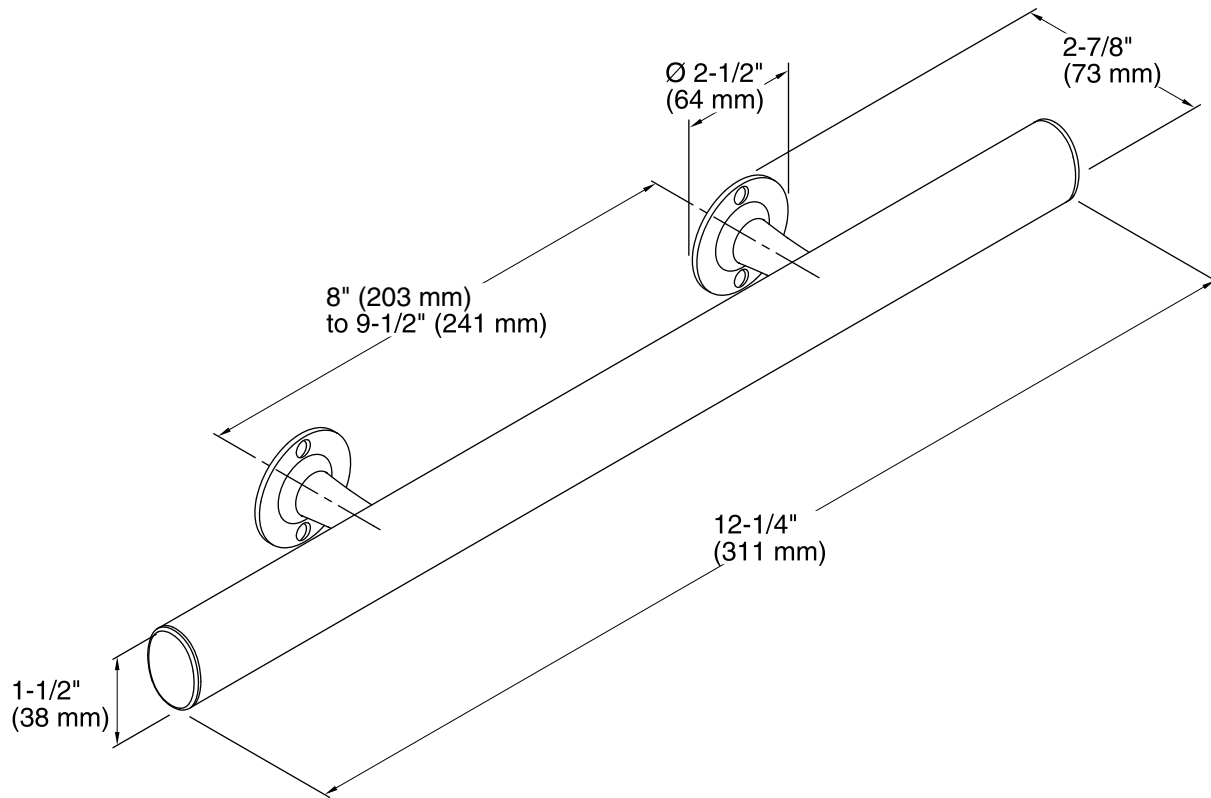

Technical Information

All product dimensions are nominal.

Notes

Install this product according to the installation guide.

WARNING: Risk of personal injury. Unless properly installed, the grab bar may not adequately support the weight of the user.

Custom Walls – Fasten grab bar directly to studs when possible. If not possible, install a 1" x 6" blocking board to studs prior to installing wallboard and finished wall material.

Sterling Age-in-Place Surrounds – Obtain backer board locations from the specification sheet for your model to select the appropriate grab bar size.