

Features

- Exposed roller design allows for effortless opening and closing of the sliding panel
- Frameless design for an open, airy look
- Back-to-back 16-7/16" (418 mm) vertical handles
- CleanCoat®+ glass coating creates a hydrophobic barrier that repels water, soap scum, and residue, saving time and protecting shower doors 10 times longer than original CleanCoat. (Based on 2021 internal wear/abrasion testing using a microfiber cloth.)
- Available in select finishes to match Artifacts faucets and accessories
- Coordinates with other products in the Artifacts collection

Material

- Frameless, heavy 3/8" (10 mm) thick Crystal Clear tempered glass door and in-line panel
- Premium construction for durability and reliability
- KOHLER finishes resist corrosion and tarnishing

Installation

- 80-7/8" (2054 mm) high, with a lofty 76-7/8" (1953 mm) minimum head clearance
- Fits opening widths 45-1/4" – 46-1/4" (1149 – 1175 mm)
- 1" (25.4 mm) width adjustment
- Out-of-plumb adjustability simplifies installation
- Door can be installed to open to the left or right to suit your bathroom layout
- For residential use only
- Not for use with cast iron shower bases

Recommended Products/Accessories

K-23723 Faucet cleaner

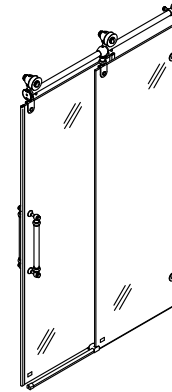

Codes/Standards

ANSI Z97.1
CPSC 16CFR 1201

KOHLER® One-Year Limited Warranty

See website for detailed warranty information.

Available Glass Options

Code	Description
L	Crystal Clear

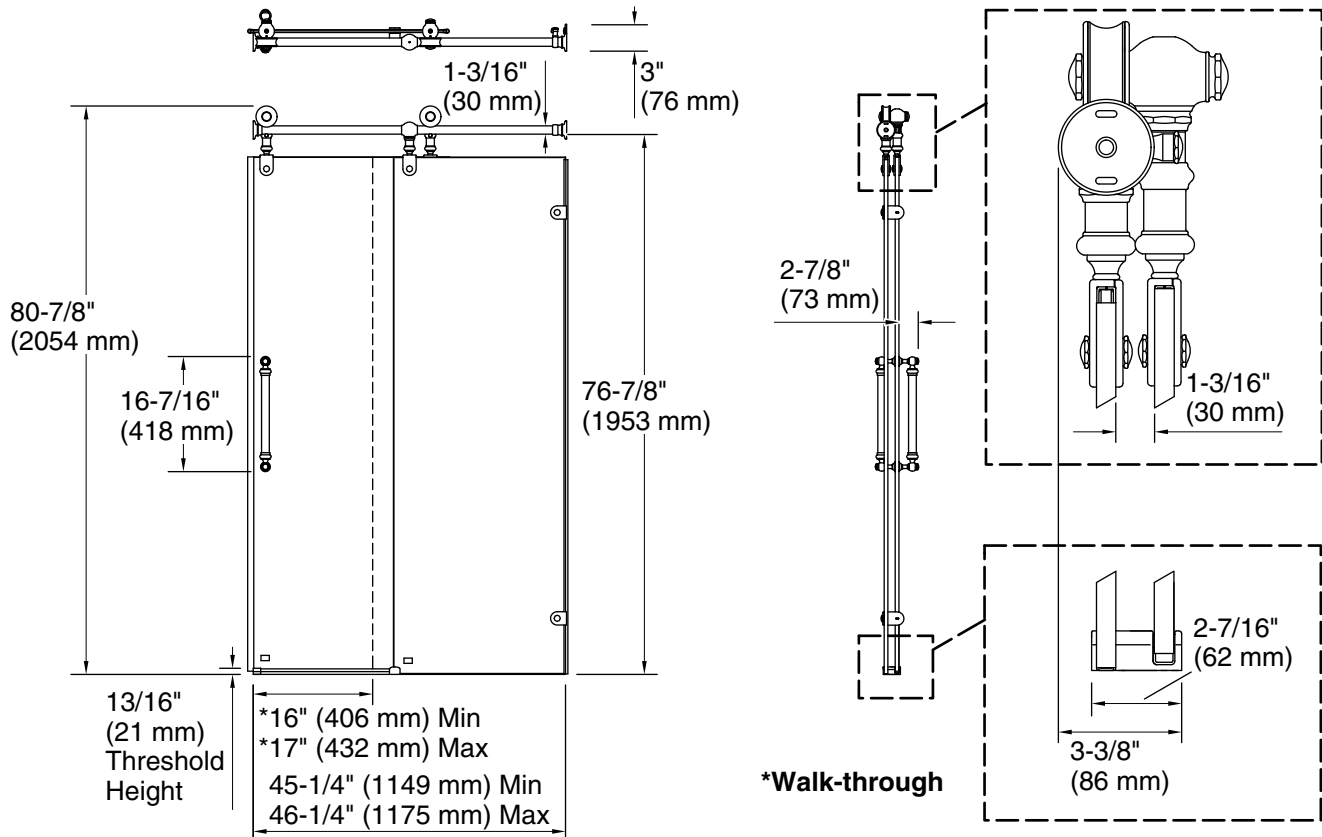

Technical Information

All product dimensions are nominal.

Installation type: For shower base installation
 Glass thickness: 3/8" (10 mm)
 Glass coating: CleanCoat+

Notes

Install this product according to the installation guide.

The vertical opening should be a minimum of 83" (2108 mm) to allow for installation clearance.